

### Surface Mount Type

Series: **FK** Type: **V**



#### Features

- Endurance : 105 °C 2000 h to 5000 h
- Low impedance (40 % to 60 % less than FC series)
- Miniaturized (30 % to 50 % less than FC series)
- Vibration-proof product (30G guaranteed) is available upon request ( $\phi 6.3 \leq$ )
- RoHS compliant

#### Specifications

Category temp. range	-55 °C to +105 °C										
Rated voltage range	6.3 V.DC to 100 V.DC										
Capacitance range	3.3 $\mu$ F to 6800 $\mu$ F										
Capacitance tolerance	$\pm 20$ % (120 Hz / +20 °C)										
Leakage current	$I \leq 0.01 CV$ or 3 ( $\mu$ A) After 2 minutes (Whichever is greater)										
Dissipation factor (tan $\delta$ )	Please see the attached characteristics list										
Characteristics at low temperature	Rated voltage (V.DC)	6.3	10	16	25	35	50	63	80	100	(Impedance ratio at 120 Hz)
	Z (-25 °C) / Z (+20 °C)	2	2	2	2	2	2	2	2	2	
	Z (-40 °C) / Z (+20 °C)	3	3	3	3	3	3	3	3	3	
	Z (-55 °C) / Z (+20 °C)	4	4	4	3	3	3	3	3	3	
Endurance	After applying rated working voltage for 2000 hours at +105 °C $\pm$ 2 °C and then being stabilized at +20 °C, capacitors shall meet the following limits. ( $\geq \phi 12.5$ and suffix "G" in $\phi 8 \times 10.2$ , $\phi 10 \times 10.2$ are 5000 hours)										
	Capacitance change	Within $\pm 30$ % of the initial value (Suffix "G" is 35 %)									
	Dissipation factor (tan $\delta$ )	$\leq 200$ % of the initial limit (Suffix "G" is 300 %)									
	Leakage current	Within the initial limit									
Shelf life	After storage for 1000 hours at +105 °C $\pm$ 2 °C with no voltage applied and then being stabilized at +20 °C, capacitors shall meet the limits specified in endurance. (With voltage treatment)										
	After reflow soldering and then being stabilized at +20 °C, capacitors shall meet the following limits.										
Resistance to soldering heat	Capacitance change	Within $\pm 10$ % of the initial value									
	Dissipation factor (tan $\delta$ )	Within the initial limit									
	Leakage current	Within the initial limit									
	AEC-Q200	AEC-Q200 compliant									

#### Frequency correction factor for ripple current

Frequency (Hz)	50, 60	120	1 k	10 k	100 k to
Correction factor	0.70	0.75	0.90	0.95	1.00

#### Marking

Example : 6.3 V.DC 22  $\mu$ F, 6.3 V.DC 3300  $\mu$ F  
Marking color : BLACK

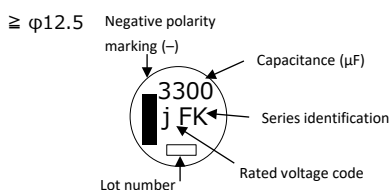
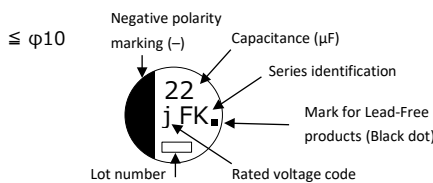

R. voltage code		Unit : V.DC	
j	6.3	H	50
A	10	J	63
C	16	K	80
E	25	2A	100
V	35		

#### Dimensions

( ) Reference size

Size code	$\phi D$	L	A, B	H	I	W	P	K
B	4.0	5.8 $\pm$ 0.3	4.3	5.5 max.	1.8	0.65 $\pm$ 0.1	1.0	0.35 <sup>+0.15</sup> <sub>-0.20</sub>
C	5.0	5.8 $\pm$ 0.3	5.3	6.5 max.	2.2	0.65 $\pm$ 0.1	1.5	0.35 <sup>+0.15</sup> <sub>-0.20</sub>
D	6.3	5.8 $\pm$ 0.3	6.6	7.8 max.	2.6	0.65 $\pm$ 0.1	1.8	0.35 <sup>+0.15</sup> <sub>-0.20</sub>
D8	6.3	7.7 $\pm$ 0.3	6.6	7.8 max.	2.6	0.65 $\pm$ 0.1	1.8	0.35 <sup>+0.15</sup> <sub>-0.20</sub>
E	8.0	6.2 $\pm$ 0.3	8.3	9.5 max.	3.4	0.65 $\pm$ 0.1	2.2	0.35 <sup>+0.15</sup> <sub>-0.20</sub>
F	8.0	10.2 $\pm$ 0.3	8.3	10.0 max.	3.4	0.90 $\pm$ 0.2	3.1	0.70 $\pm$ 0.2
G	10.0	10.2 $\pm$ 0.3	10.3	12.0 max.	3.5	0.90 $\pm$ 0.2	4.6	0.70 $\pm$ 0.2
H13	12.5	13.5 $\pm$ 0.5	13.5	15.0 max.	4.7	0.90 $\pm$ 0.3	4.4	0.70 $\pm$ 0.3
J16	16.0	16.5 $\pm$ 0.5	17.0	19.0 max.	5.5	1.20 $\pm$ 0.3	6.7	0.70 $\pm$ 0.3
K16	18.0	16.5 $\pm$ 0.5	19.0	21.0 max.	6.7	1.20 $\pm$ 0.3	6.7	0.70 $\pm$ 0.3

\*The dimensions of the vibration-proof products, please refer to the page of the mounting specification.

### Dimensions (Vibration-proof products)

\* The size and shape are different from standard products. Please inquire details of our company.

< Size code : D, D8 >

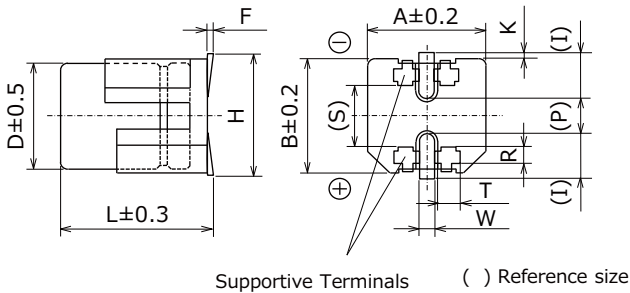

< Size code : E, F, G, H13, J16, K16, K21 >

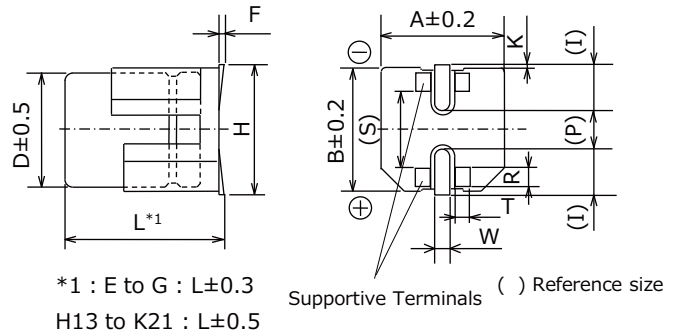

Supportive Terminals ( ) Reference size

\*1 : E to G : L±0.3  
H13 to K21 : L±0.5

Supportive Terminals ( ) Reference size

Unit : mm

Size code	φD	L	A, B	H max.	F	I	W	P	K	R	S	T
D	6.3	6.1	6.6	7.8	0 to +0.15	2.4	0.65±0.1	2.2	0.35 <sup>+0.15</sup> <sub>-0.20</sub>	1.1±0.2	3.3±0.2	1.05±0.2
D8	6.3	8.0	6.6	7.8	0 to +0.15	2.4	0.65±0.1	2.2	0.35 <sup>+0.15</sup> <sub>-0.20</sub>	1.1±0.2	3.3±0.2	1.05±0.2
E	8.0	6.5	8.3	9.5	0 to +0.15	3.4	0.7±0.1	2.2	0.35 <sup>+0.15</sup> <sub>-0.20</sub>	0.70±0.2	5.3±0.2	1.7±0.2
F	8.0	10.5	8.3	10.0	0 to +0.15	3.4	1.2±0.2	3.1	0.70±0.2	0.70±0.2	5.3±0.2	1.3±0.2
G	10.0	10.5	10.3	12.0	0 to +0.15	3.5	1.2±0.2	4.6	0.70±0.2	0.70±0.2	6.9±0.2	1.3±0.2
H13	12.5	13.8	13.5	15.0	-0.1 to +0.15	4.7	1.2±0.2	4.4	0.70±0.3	2.2±0.2	7.1±0.2	2.4±0.2
J16	16.0	16.8	17.0	19.0	-0.1 to +0.15	5.5	1.4±0.2	6.7	0.70±0.3	3.0±0.2	9.0±0.2	1.9±0.2
K16	18.0	16.8	19.0	21.0	-0.1 to +0.15	6.7	1.4±0.2	6.7	0.70±0.3	3.0±0.2	11.0±0.2	1.9±0.2
K21	18.0	21.8	19.0	21.0	-0.1 to +0.15	6.7	1.4±0.2	6.7	0.70±0.3	3.0±0.2	11.0±0.2	1.9±0.2

### Land / Pad pattern

The circuit board land/pad pattern size for chip capacitors is specified in the following table. The land pitch influences installation strength and consider it.

#### ● Standard products

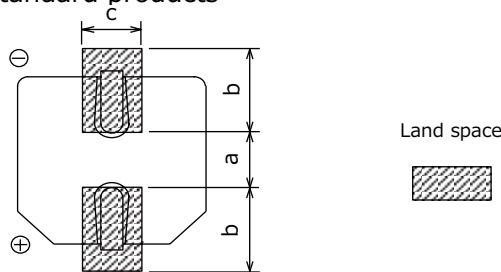

(Table of board land size vs. capacitor size)

Size code	a	b	c
B (φ4)	1.0	2.5	1.6
C (φ5)	1.5	2.8	1.6
D (φ6.3)	1.8	3.2	1.6
D8 (φ6.3x7.7L)	1.8	3.2	1.6
E (φ8x6.2L)	2.2	4.0	1.6
F (φ8x10.2L)	3.1	4.0	2.0
G (φ10x10.2L)	4.6	4.1	2.0
H (φ12.5)	4.0	5.7	2.0
J (φ16)	6.0	6.5	2.5
K (φ18)	6.0	7.5	2.5

Unit : mm

When size "a" is wide, back fillet can be made, decreasing fitting strength.

#### ● Vibration-proof products

< Size code : D, D8 >

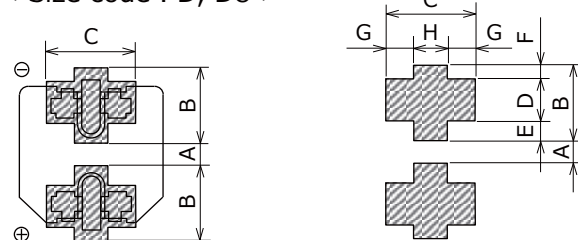

(Table of board land size vs. capacitor size)

Size code	A	B	C	D	E	F	G	H
D (φ6.3xL6.1)	1.2	3.6	3.2	2.0	0.95	0.65	1.0	1.2
D8 (φ6.3xL8.0)	1.2	3.6	3.2	2.0	0.95	0.65	1.0	1.2
E (φ8x6.5L)	1.8	4.2	5.0	1.3	1.5	1.4	1.5	2.0
F (φ8x10.5L)	2.7	4.0	4.7	1.3	1.0	1.7	1.1	2.5
G (φ10)	3.9	4.4	4.7	1.3	1.2	1.9	1.1	2.5
H (φ12.5)	3.9	6.0	6.9	2.8	1.3	1.9	2.2	2.5
J (φ16)	5.8	6.8	6.2	3.6	1.3	1.9	1.7	2.8
K (φ18)	5.8	7.3	6.2	3.6	1.8	1.9	1.7	2.8

Unit : mm

When size "A" is wide, back fillet can be made, decreasing fitting strength.

< Size code : E, F, G, H, J, K >

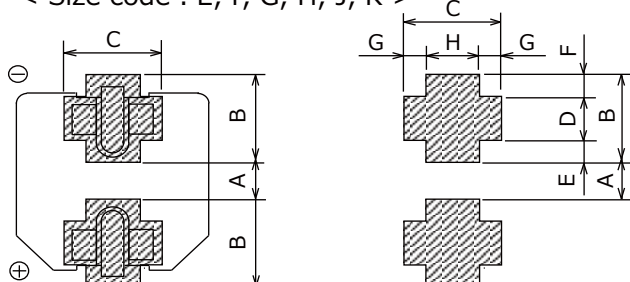

\* Take mounting conditions, solderability and fitting strength into consideration when selecting parts for your company's design.

\* The vibration-proof capacitors of size φ6.3 has support terminals extending from the bottom side to the lead edge. Then, make sure to find appropriate soldering conditions to form fillet on the support terminals if required for appearance inspection.

### Characteristics list

Endurance : 105 °C 2000 h (≥ φ12.5 : 5000 h)

Rated volt. (V.DC)	Cap. (±20 %) (μF)	Case size (mm)			Size code *1	Specification			Part No.		Reflow	Min. Packaging Q'ty
		φD	L			Ripple current *2 (mA r.m.s.)	ESR *3 (Ω)	tan δ *4	Standard	Vibration-proof		
			Standard	Vibration-proof								
6.3	22	4	5.8	—	B	90	1.35	0.26	EEEFK0J220R	—	(1)	2000
	47	4	5.8	—	(B)	90	1.35	0.26	EEEFK0J470UR	—	(1)	2000
		5	5.8	—	C	160	0.70	0.26	EEEFK0J470R	—	(1)	1000
	100	5	5.8	—	(C)	160	0.70	0.26	EEEFK0J101UR	—	(1)	1000
		6.3	5.8	6.1	D	240	0.36	0.26	EEEFK0J101P	EEEFK0J101V	(1)	1000
	220	6.3	5.8	6.1	D	240	0.36	0.26	EEEFK0J221P	EEEFK0J221V	(1)	1000
	330	6.3	7.7	8.0	D8	280	0.34	0.26	EEEFK0J331XP	EEEFK0J331XV	(1)	900
		8	6.2	6.5	E	300	0.26	0.26	EEEFK0J331P	EEEFK0J331V	(2)	1000
	470	8	10.2	10.5	F	600	0.16	0.26	EEEFK0J471P	EEEFK0J471V	(2)	500
	1000	8	10.2	10.5	F	600	0.16	0.26	EEEFK0J102P	EEEFK0J102V	(2)	500
10	1500	10	10.2	10.5	G	850	0.08	0.26	EEEFK0J152P	EEEFK0J152V	(2)	500
	3300	12.5	13.5	13.8	H13	1100	0.06	0.30	EEVFK0J332Q	EEVFK0J332V	(3)	200
	6800	16	16.5	16.8	J16	1800	0.035	0.36	EEVFK0J682M	EEVFK0J682V	(3)	125
	22	4	5.8	—	B	90	1.35	0.19	EEEFK1A220R	—	(1)	2000
		4	5.8	—	(B)	90	1.35	0.19	EEEFK1A330UR	—	(1)	2000
	33	5	5.8	—	C	160	0.70	0.19	EEEFK1A330R	—	(1)	1000
		6.3	5.8	6.1	D	240	0.36	0.19	EEEFK1A151P	EEEFK1A151V	(1)	1000
	150	6.3	7.7	8.0	D8	280	0.34	0.19	EEEFK1A221XP	EEEFK1A221XV	(1)	900
	220	8	6.2	6.5	E	300	0.26	0.19	EEEFK1A221P	EEEFK1A221V	(2)	1000
		8	10.2	10.5	F	600	0.16	0.19	EEEFK1A331P	EEEFK1A331V	(2)	500
330	8	10.2	10.5	F	600	0.16	0.19	EEEFK1A471P	EEEFK1A471V	(2)	500	
470	8	10.2	10.5	F	600	0.16	0.19	EEEFK1A681P	EEEFK1A681V	(2)	500	
680	8	10.2	10.5	F	600	0.16	0.19	EEEFK1A102P	EEEFK1A102V	(2)	500	
1000	10	10.2	10.5	G	850	0.08	0.19	EEVFK1A222Q	EEVFK1A222V	(3)	200	
2200	12.5	13.5	13.8	H13	1100	0.06	0.21	EEVFK1A472M	EEVFK1A472V	(3)	125	
4700	16	16.5	16.8	J16	1800	0.035	0.25	EEVFK1A682M	EEVFK1A682V	(3)	125	
6800	18	16.5	16.8	K16	2060	0.033	0.29	EEVFK1C100R	—	(1)	2000	
16	10	4	5.8	—	B	90	1.35	0.16	EEEFK1C220UR	—	(1)	2000
	22	4	5.8	—	(B)	90	1.35	0.16	EEEFK1C220R	—	(1)	1000
		5	5.8	—	C	160	0.70	0.16	EEEFK1C470UR	—	(1)	1000
	47	5	5.8	—	(C)	160	0.70	0.16	EEEFK1C470P	EEEFK1C470V	(1)	1000
		6.3	5.8	6.1	D	240	0.36	0.16	EEEFK1C680P	EEEFK1C680V	(1)	1000
	68	6.3	5.8	6.1	D	240	0.36	0.16	EEEFK1C101P	EEEFK1C101V	(1)	1000
	100	6.3	5.8	6.1	D	240	0.36	0.16	EEEFK1C151XP	EEEFK1C151XV	(1)	900
	150	6.3	7.7	8.0	D8	280	0.34	0.16	EEEFK1C221XP	EEEFK1C221XV	(1)	900
		8	6.2	6.5	E	300	0.26	0.16	EEEFK1C221P	EEEFK1C221V	(2)	1000
	330	8	10.2	10.5	F	600	0.16	0.16	EEEFK1C331P	EEEFK1C331V	(2)	500
470	8	10.2	10.5	F	600	0.16	0.16	EEEFK1C471P	EEEFK1C471V	(2)	500	
680	10	10.2	10.5	G	850	0.08	0.16	EEEFK1C681P	EEEFK1C681V	(2)	500	
1500	12.5	13.5	13.8	H13	1100	0.06	0.16	EEVFK1C152Q	EEVFK1C152V	(3)	200	
3300	16	16.5	16.8	J16	1800	0.035	0.20	EEVFK1C332M	EEVFK1C332V	(3)	125	
4700	18	16.5	16.8	K16	2060	0.033	0.22	EEVFK1C472M	EEVFK1C472V	(3)	125	
25	10	4	5.8	—	B	90	1.35	0.14	EEEFK1E100R	—	(1)	2000
	22	5	5.8	—	C	160	0.70	0.14	EEEFK1E220R	—	(1)	1000
		5	5.8	—	(C)	160	0.70	0.14	EEEFK1E330UR	—	(1)	1000
	33	6.3	5.8	6.1	D	240	0.36	0.14	EEEFK1E330P	EEEFK1E330V	(1)	1000
		6.3	5.8	6.1	D	240	0.36	0.14	EEEFK1E470P	EEEFK1E470V	(1)	1000
	68	6.3	5.8	6.1	D	240	0.36	0.14	EEEFK1E680P	EEEFK1E680V	(1)	1000
	100	6.3	7.7	8.0	D8	280	0.34	0.14	EEEFK1E101XP	EEEFK1E101XV	(1)	900
		8	6.2	6.5	E	300	0.26	0.14	EEEFK1E101P	EEEFK1E101V	(2)	1000
	150	8	10.2	10.5	F	600	0.16	0.14	EEEFK1E151P	EEEFK1E151V	(2)	500
	220	8	10.2	10.5	F	600	0.16	0.14	EEEFK1E221P	EEEFK1E221V	(2)	500
330	8	10.2	10.5	F	600	0.16	0.14	EEEFK1E331P	EEEFK1E331V	(2)	500	
470	10	10.2	10.5	G	850	0.08	0.14	EEEFK1E471P	EEEFK1E471V	(2)	500	
1000	12.5	13.5	13.8	H13	1100	0.06	0.14	EEVFK1E102Q	EEVFK1E102V	(3)	200	
1500	16	16.5	16.8	J16	1800	0.035	0.14	EEVFK1E152M	EEVFK1E152V	(3)	125	
2200	16	16.5	16.8	J16	1800	0.035	0.16	EEVFK1E222M	EEVFK1E222V	(3)	125	
3300	18	16.5	16.8	K16	2060	0.033	0.18	EEVFK1E332M	EEVFK1E332V	(3)	125	

\*1: Size code ( ): Miniaturization product

\*2: Ripple current (100 kHz / +105 °C)

\*3: ESR (100 kHz / +20 °C)

\*4: tan δ (120 Hz / +20 °C)

• Please refer to the page of "Reflow Profile" and "The Taping Dimensions".

### Characteristics list

Endurance : 105 °C 2000 h (≥ φ12.5 : 5000 h)

Rated volt. (V.DC)	Cap. (±20 %) (μF)	Case size (mm)			Size code *1	Specification			Part No.		Reflow	Min. Packaging Q'ty	
		φD	L			Ripple current *2 (mA r.m.s.)	ESR *3 (Ω)	tan δ *4	Standard	Vibration-proof			Taping (pcs)
			Standard	Vibration-proof									
35	4.7	4	5.8	—	B	90	1.35	0.12	EEEFK1V4R7R	—	(1)	2000	
	10	4	5.8	—	(B)	90	1.35	0.12	EEEFK1V100UR	—	(1)	2000	
		5	5.8	—	C	160	0.70	0.12	EEEFK1V100R	—	(1)	1000	
	22	5	5.8	—	C	160	0.70	0.12	EEEFK1V220R	—	(1)	1000	
	33	6.3	5.8	6.1	D	240	0.36	0.12	EEEFK1V330P	EEEFK1V330V	(1)	1000	
	47	6.3	5.8	6.1	D	240	0.36	0.12	EEEFK1V470P	EEEFK1V470V	(1)	1000	
	68	6.3	7.7	8	D8	280	0.34	0.12	EEEFK1V680XP	EEEFK1V680XV	(1)	900	
	100	6.3	7.7	8	D8	280	0.34	0.12	EEEFK1V101XP	EEEFK1V101XV	(1)	900	
		8	10.2	10.5	F	600	0.16	0.12	EEEFK1V101P	EEEFK1V101V	(2)	500	
	150	8	10.2	10.5	F	600	0.16	0.12	EEEFK1V151P	EEEFK1V151V	(2)	500	
	220	8	10.2	10.5	F	600	0.16	0.12	EEEFK1V221P	EEEFK1V221V	(2)	500	
	330	10	10.2	10.5	G	850	0.08	0.12	EEEFK1V331P	EEEFK1V331V	(2)	500	
	470	12.5	13.5	13.8	H13	1100	0.06	0.12	EEVFK1V471Q	EEVFK1V471V	(3)	200	
	680	12.5	13.5	13.8	H13	1100	0.06	0.12	EEVFK1V681Q	EEVFK1V681V	(3)	200	
1000	16	16.5	16.8	J16	1800	0.035	0.12	EEVFK1V102M	EEVFK1V102V	(3)	125		
1500	16	16.5	16.8	J16	1800	0.035	0.12	EEVFK1V152M	EEVFK1V152V	(3)	125		
50	4.7	4	5.8	—	B	60	2.90	0.10	EEEFK1H4R7R	—	(1)	2000	
	10	5	5.8	—	(C)	85	1.52	0.10	EEEFK1H100UR	—	(1)	1000	
		6.3	5.8	6.1	D	165	0.88	0.10	EEEFK1H100P	EEEFK1H100V	(1)	1000	
	22	6.3	5.8	6.1	D	165	0.88	0.10	EEEFK1H220P	EEEFK1H220V	(1)	1000	
	33	6.3	7.7	8	D8	195	0.68	0.10	EEEFK1H330XP	EEEFK1H330XV	(1)	900	
		8	6.2	6.5	E	195	0.68	0.10	EEEFK1H330P	EEEFK1H330V	(2)	1000	
	47	6.3	7.7	8	D8	195	0.68	0.10	EEEFK1H470XP	EEEFK1H470XV	(1)	900	
		8	6.2	6.5	E	195	0.68	0.10	EEEFK1H470P	EEEFK1H470V	(2)	1000	
	100	8	10.2	10.5	F	350	0.34	0.10	EEEFK1H101P	EEEFK1H101V	(2)	500	
	150	10	10.2	10.5	G	670	0.18	0.10	EEEFK1H151P	EEEFK1H151V	(2)	500	
	220	10	10.2	10.5	G	670	0.18	0.10	EEEFK1H221P	EEEFK1H221V	(2)	500	
	330	12.5	13.5	13.8	H13	900	0.12	0.10	EEVFK1H331Q	EEVFK1H331V	(3)	200	
	390	12.5	13.5	13.8	H13	900	0.12	0.10	EEVFK1H391Q	EEVFK1H391V	(3)	200	
	470	16	16.5	16.8	J16	1610	0.073	0.10	EEVFK1H471M	EEVFK1H471V	(3)	125	
560	16	16.5	16.8	J16	1610	0.073	0.10	EEVFK1H561M	EEVFK1H561V	(3)	125		
680	16	16.5	16.8	J16	1610	0.073	0.10	EEVFK1H681M	EEVFK1H681V	(3)	125		
1000	16	16.5	16.8	J16	1610	0.073	0.10	EEVFK1H102M	EEVFK1H102V	(3)	125		
63	4.7	5	5.8	—	C	50	3.00	0.08	EEEFK1J4R7R	—	(1)	1000	
	10	6.3	5.8	6.1	D	80	1.50	0.08	EEEFK1J100P	EEEFK1J100V	(1)	1000	
		6.3	7.7	8	D8	120	1.20	0.08	EEEFK1J220XP	EEEFK1J220XV	(1)	900	
	22	8	6.2	6.5	E	120	1.20	0.08	EEEFK1J220P	EEEFK1J220V	(2)	1000	
	33	8	10.2	10.5	F	250	0.65	0.08	EEEFK1J330P	EEEFK1J330V	(2)	500	
	47	8	10.2	10.5	F	250	0.65	0.08	EEEFK1J470P	EEEFK1J470V	(2)	500	
	68	8	10.2	10.5	(F)	250	0.65	0.08	EEEFK1J680UP	EEEFK1J680UV	(2)	500	
	100	10	10.2	10.5	G	400	0.35	0.08	EEEFK1J101P	EEEFK1J101V	(2)	500	
	150	12.5	13.5	13.8	H13	800	0.16	0.08	EEVFK1J151Q	EEVFK1J151V	(3)	200	
	220	12.5	13.5	13.8	H13	800	0.16	0.08	EEVFK1J221Q	EEVFK1J221V	(3)	200	
	470	16	16.5	16.8	J16	1410	0.082	0.08	EEVFK1J471M	EEVFK1J471V	(3)	125	
	680	18	16.5	16.8	K16	1690	0.08	0.08	EEVFK1J681M	EEVFK1J681V	(3)	125	
	80	3.3	5	5.8	—	C	25	5.00	0.08	EEEFK1K3R3R	—	(1)	1000
		4.7	6.3	5.8	6.1	D	40	3.00	0.08	EEEFK1K4R7P	EEEFK1K4R7V	(1)	1000
10		6.3	7.7	8	D8	60	2.40	0.08	EEEFK1K100XP	EEEFK1K100XV	(1)	900	
		8	6.2	6.5	E	60	2.40	0.08	EEEFK1K100P	EEEFK1K100V	(2)	1000	
22		8	10.2	10.5	F	130	1.30	0.08	EEEFK1K220P	EEEFK1K220V	(2)	500	
33		8	10.2	10.5	F	130	1.30	0.08	EEEFK1K330P	EEEFK1K330V	(2)	500	
47		10	10.2	10.5	G	200	0.70	0.08	EEEFK1K470P	EEEFK1K470V	(2)	500	
68		12.5	13.5	13.8	H13	500	0.32	0.08	EEVFK1K680Q	EEVFK1K680V	(3)	200	
100		12.5	13.5	13.8	H13	500	0.32	0.08	EEVFK1K101Q	EEVFK1K101V	(3)	200	
150		12.5	13.5	13.8	H13	500	0.32	0.08	EEVFK1K151Q	EEVFK1K151V	(3)	200	
330		16	16.5	16.8	J16	793	0.17	0.08	EEVFK1K331M	EEVFK1K331V	(3)	125	
470		18	16.5	16.8	K16	917	0.153	0.08	EEVFK1K471M	EEVFK1K471V	(3)	125	

\*1: Size code ( ): Miniaturization product

\*2: Ripple current (100 kHz / +105 °C)

\*3: ESR (100 kHz / +20 °C)

\*4: tan δ (120 Hz / +20 °C)

• Please refer to the page of "Reflow Profile" and "The Taping Dimensions".

### Characteristics list

Endurance : 105 °C 2000 h (≥ φ12.5 : 5000 h)

Rated volt. (V.DC)	Cap. (±20 %) (μF)	Case size (mm)			Size code *1	Specification			Part No.		Reflow	Min. Packaging Q'ty
		φD	L			Ripple current *2 (mA r.m.s.)	ESR*3 (Ω)	tan δ*4	Standard	Vibration-proof		
			Standard	Vibration-proof								
100	22	8	10.2	10.5	F	130	1.30	0.07	EEEFK2A220P	EEEFK2A220V	(2)	500
	33	10	10.2	10.5	G	200	0.70	0.07	EEEFK2A330P	EEEFK2A330V	(2)	500
	47	12.5	13.5	13.8	H13	500	0.32	0.07	EEVFK2A470Q	EEVFK2A470V	(3)	200
	68	12.5	13.5	13.8	H13	500	0.32	0.07	EEVFK2A680Q	EEVFK2A680V	(3)	200
	100	16	16.5	16.8	J16	793	0.17	0.07	EEVFK2A101M	EEVFK2A101V	(3)	125
	150	16	16.5	16.8	J16	793	0.17	0.07	EEVFK2A151M	EEVFK2A151V	(3)	125
	220	18	16.5	16.8	K16	917	0.153	0.07	EEVFK2A221M	EEVFK2A221V	(3)	125
	330	18	16.5	16.8	K16	917	0.153	0.07	EEVFK2A331M	EEVFK2A331V	(3)	125

Endurance : 105 °C 5000 h

Rated volt. (V.DC)	Cap. (±20 %) (μF)	Case size (mm)			Size code *1	Specification			Part No.		Reflow	Min. Packaging Q'ty
		φD	L			Ripple current *2 (mA r.m.s.)	ESR*3 (Ω)	tan δ*4	Standard	Vibration-proof		
			Standard	Vibration-proof								
6.3	470	8	10.2	10.5	F	600	0.16	0.26	EEEFK0J471GP	EEEFK0J471GV	(2)	500
	1000	8	10.2	10.5	F	600	0.16	0.26	EEEFK0J102GP	EEEFK0J102GV	(2)	500
	1500	10	10.2	10.5	G	850	0.08	0.26	EEEFK0J152GP	EEEFK0J152GV	(2)	500
10	330	8	10.2	10.5	F	600	0.16	0.19	EEEFK1A331GP	EEEFK1A331GV	(2)	500
	470	8	10.2	10.5	F	600	0.16	0.19	EEEFK1A471GP	EEEFK1A471GV	(2)	500
	680	8	10.2	10.5	F	600	0.16	0.19	EEEFK1A681GP	EEEFK1A681GV	(2)	500
	1000	10	10.2	10.5	G	850	0.08	0.19	EEEFK1A102GP	EEEFK1A102GV	(2)	500
16	330	8	10.2	10.5	F	600	0.16	0.16	EEEFK1C331GP	EEEFK1C331GV	(2)	500
	470	8	10.2	10.5	F	600	0.16	0.16	EEEFK1C471GP	EEEFK1C471GV	(2)	500
	680	10	10.2	10.5	G	850	0.08	0.16	EEEFK1C681GP	EEEFK1C681GV	(2)	500
25	150	8	10.2	10.5	F	600	0.16	0.14	EEEFK1E151GP	EEEFK1E151GV	(2)	500
	220	8	10.2	10.5	F	600	0.16	0.14	EEEFK1E221GP	EEEFK1E221GV	(2)	500
	330	8	10.2	10.5	F	600	0.16	0.14	EEEFK1E331GP	EEEFK1E331GV	(2)	500
	470	10	10.2	10.5	G	850	0.08	0.14	EEEFK1E471GP	EEEFK1E471GV	(2)	500
35	100	8	10.2	10.5	F	600	0.16	0.12	EEEFK1V101GP	EEEFK1V101GV	(2)	500
	150	8	10.2	10.5	F	600	0.16	0.12	EEEFK1V151GP	EEEFK1V151GV	(2)	500
	220	8	10.2	10.5	F	600	0.16	0.12	EEEFK1V221GP	EEEFK1V221GV	(2)	500
	330	10	10.2	10.5	G	850	0.08	0.12	EEEFK1V331GP	EEEFK1V331GV	(2)	500
50	100	8	10.2	10.5	F	350	0.34	0.10	EEEFK1H101GP	EEEFK1H101GV	(2)	500
	150	10	10.2	10.5	G	670	0.18	0.10	EEEFK1H151GP	EEEFK1H151GV	(2)	500
	220	10	10.2	10.5	G	670	0.18	0.10	EEEFK1H221GP	EEEFK1H221GV	(2)	500

\*1: Size code ( ): Miniaturization product

\*2: Ripple current (100 kHz / +105 °C)

\*3: ESR (100 kHz / +20 °C)

\*4: tan δ (120 Hz / +20 °C)

• Please refer to the page of "Reflow Profile" and "The Taping Dimensions".

## Guidelines and precautions regarding the technical information and use of our products described in this online catalog.

- If you want to use our products described in this online catalog for applications requiring special qualities or reliability, or for applications where the failure or malfunction of the products may directly jeopardize human life or potentially cause personal injury (e.g. aircraft and aerospace equipment, traffic and transportation equipment, combustion equipment, medical equipment, accident prevention, anti-crime equipment, and/or safety equipment), it is necessary to verify whether the specifications of our products fit to such applications. Please ensure that you will ask and check with our inquiry desk as to whether the specifications of our products fit to such applications use before you use our products.
- The quality and performance of our products as described in this online catalog only apply to our products when used in isolation. Therefore, please ensure you evaluate and verify our products under the specific circumstances in which our products are assembled in your own products and in which our products will actually be used.
- If you use our products in equipment that requires a high degree of reliability, regardless of the application, it is recommended that you set up protection circuits and redundancy circuits in order to ensure safety of your equipment.
- The products and product specifications described in this online catalog are subject to change for improvement without prior notice. Therefore, please be sure to request and confirm the latest product specifications which explain the specifications of our products in detail, before you finalize the design of your applications, purchase, or use our products.
- The technical information in this online catalog provides examples of our products' typical operations and application circuits. We do not guarantee the non-infringement of third party's intellectual property rights and we do not grant any license, right, or interest in our intellectual property.
- If any of our products, product specifications and/or technical information in this online catalog is to be exported or provided to non-residents, the laws and regulations of the exporting country, especially with regard to security and export control, shall be observed.

## <Regarding the Certificate of Compliance with the EU RoHS Directive/REACH Regulations>

- The switchover date for compliance with the RoHS Directive/REACH Regulations varies depending on the part number or series of our products.
- When you use the inventory of our products for which it is unclear whether those products are compliant with the RoHS Directive/REACH Regulation, please select "Sales Inquiry" in the website inquiry form and contact us.

**We do not take any responsibility for the use of our products outside the scope of the specifications, descriptions, guidelines and precautions described in this online catalog.**

---